

FAG

3306-BD-XL-2Z-TVH-C3

Angular contact ball bearing

Schaeffler ID:
0627077600030Angular contact ball bearing 33..-BD-
XL-2Z-TVH, double row, X-life, shields,
plastic cage

X-life

Technical information

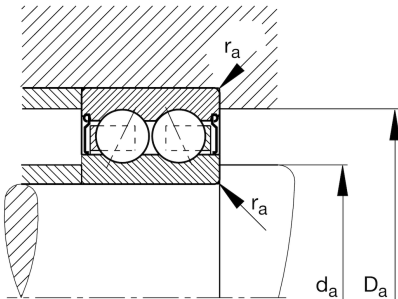
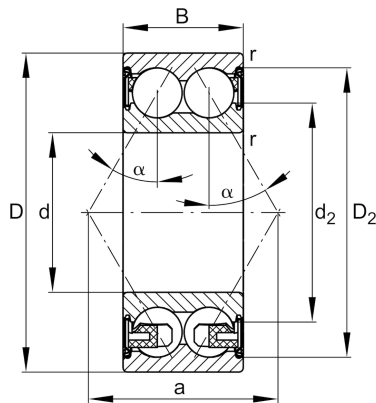

Main Dimensions & Performance Data

d	30 mm	Bore diameter
D	72 mm	Outside diameter
B	30.2 mm	Width
C_r	43,000 N	Basic dynamic load rating, radial
C_{0r}	29,500 N	Basic static load rating, radial
C_{ur}	2,050 N	Fatigue load limit, radial
n_G	7,800 1/min	Limiting speed
n_{gr}	8,500 1/min	Reference speed
	0.55 kg	Weight

Mounting dimensions

$d_{a \min}$	37 mm	Minimum diameter shaft shoulder
$D_{a \max}$	65 mm	Maximum diameter of housing shoulder
$r_{a \max}$	1 mm	Maximum fillet radius

Dimensions

r_{\min}	1.1 mm	Minimum chamfer dimension
D_2	63.5 mm	Caliber diameter outer ring
d_2	44.4 mm	Caliber diameter inner ring
a	41.9 mm	Distance between the apexes of the pressure cones
α	30 °	Contact angle

Temperature range

T_{\min}	-20 °C	Operating temperature min.
T_{\max}	120 °C	Operating temperature max.